

"APPLICATION GUIDE" (INFINITY AIR GRATE-55 SERIES.)

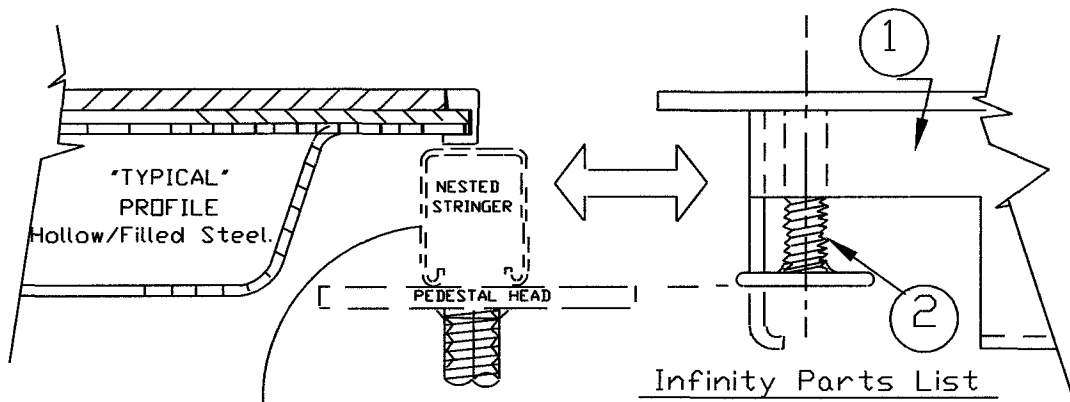

Infinity Parts List

- ① Infinity Grate. (P/N: ISG55-15)
- ② Leveling Leg. (P/N: CLX)

MFR. Tate/#2989
 Stringer dims, 22.15/16" L
 5/8" W
 1.1/8" H
 Hole Ctrs, 21.3/4"
 Stringer Type: Bolt on.

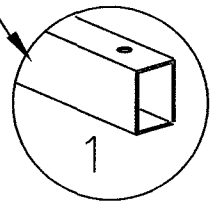

MFR: IAR/Atlantic
 Stringer dims, 23" L
 13/16" W
 1.1/4" H
 Hole Ctrs, 21.3/4"
 Stringer Type: Heavy Duty Bolt on.

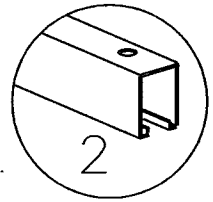

MFR. Tate
 Stringer dims, 23" L
 13/16" W
 1.1/4" H
 Hole Ctrs, 22"
 Stringer Type: Bolt on.

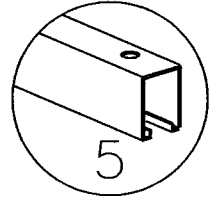

MFR: Unknown
 Stringer dims, 22.7/8" L
 1" W
 1" H
 Hole Ctrs, 22"
 Stringer Type: Bolt on.

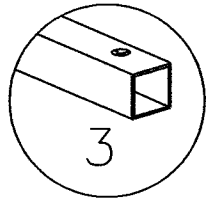

MFR. Severn
 Stringer dims, 23.1/16" L
 13/16" W
 1.1/16" H
 Hole Ctrs, 22.1/2"
 Stringer Type: Drop on.

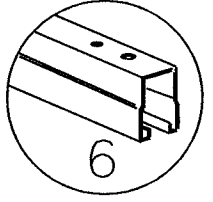

MFR: ASM Modular Systems.
 Stringer dims, 22.15/16" L
 13/16" W
 1.1/4" H
 Hole Ctrs, 22"
 Stringer Type: Bolt on.

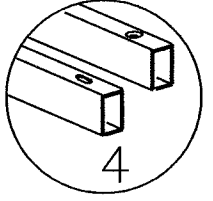

MFR. Donn Bolted
 Stringer dims, 23.1/16 L
 13/16" W
 1.1/16" H
 Hole Ctrs, 22"
 Stringer Type: Bolt on.

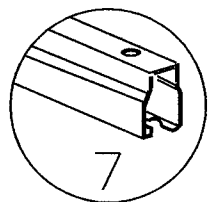

USE INFINITY PARTS LIST ABOVE
 FOR STRINGER APPLICATIONS.
 SHOWN ON LOWER PAGE AREA.

OPSTOCK, INC. 401 HALL STREET, SW. GRAND RAPIDS, MI 49503 P: 616 241 6720 F: 616 241 6730			
SIZE	FSCM NO.	DWG NO.	REV
		APPLICATION GUIDE	
SCALE: NTS.		DWG 39C-1	

"APPLICATION GUIDE" (INFINITY AIR GRATE-55 SERIES.)

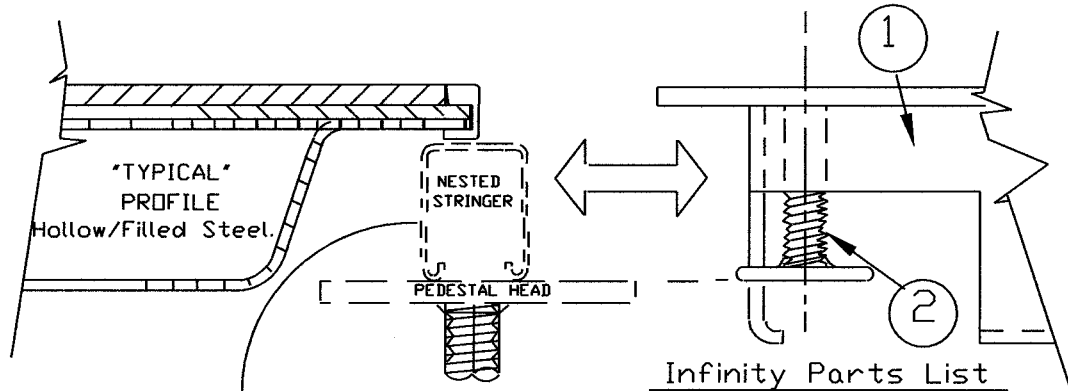

Infinity Parts List

- * ① Infinity Grate. (P/N: ISG55-15)
- ② Leveling Leg. (P/N: CLX).

MFR. Tate Heavy Duty
 Stringer dims, 23" L
 13/16" W
 1.1/4" H
 Hole Ctrs, 22"
 Stringer Type: Bolt on.
 Heavy Duty Floor. Tate #590956 Bolt on.

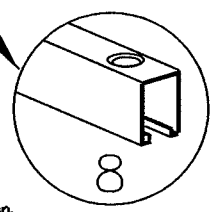

MFR. Maxcess BG2
 Stringer dims, 22.7/8" L
 13/16" W
 1.1/4" H
 Hole Ctrs, 22"
 Stringer Type: Bolt on.

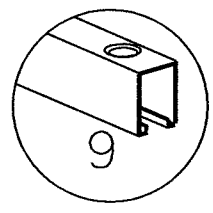

*
MFR. C-Tec/IAR/Haworth
 Stringer dims, 22.7/8" L
 1.3/16" W
 1.1/16" H
 Hole Ctrs, 22"
 Stringer Type: Bolt on.

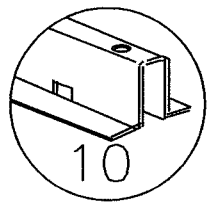

MFR. Tate/S-707
 Stringer dims, 22.13/16" L
 5/8" W
 1" H
 Hole Ctrs, 22.3/8"
 Stringer Type. Drop on.

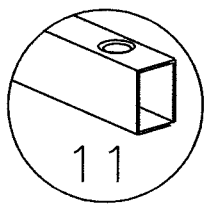

MFR. Custom
 Stringer dims, 23.3/16 L
 13/16" W
 1.1/4" H
 Hole Ctrs, 22.3/8"
 Stringer Type: Bolt on.

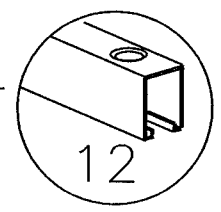

MFR. Severn
 Stringer dims, 23.1/16" L
 13/16" W
 1.1/16" H
 Hole Ctrs, 20.1/2"
 Stringer Type: Cuff-Link.

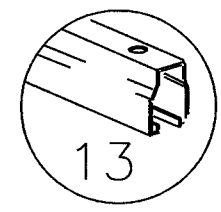

MFR. Lisky Mark 40
 Stringer dims, 22.7/8" L
 7/8" W
 1.1/8" H
 Hole Ctrs, 22"
 Stringer Type: Bolt on.

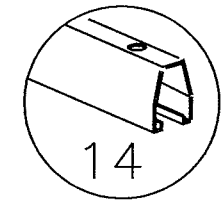

* Note-"Tight Fit" Probability
 USE INFINITY PARTS LIST ABOVE FOR STRINGER APPLICATIONS.
 SHOWN ON LOWER PAGE AREA.

"APPLICATION GUIDE" (INFINITY AIR GRATE-55 SERIES.)

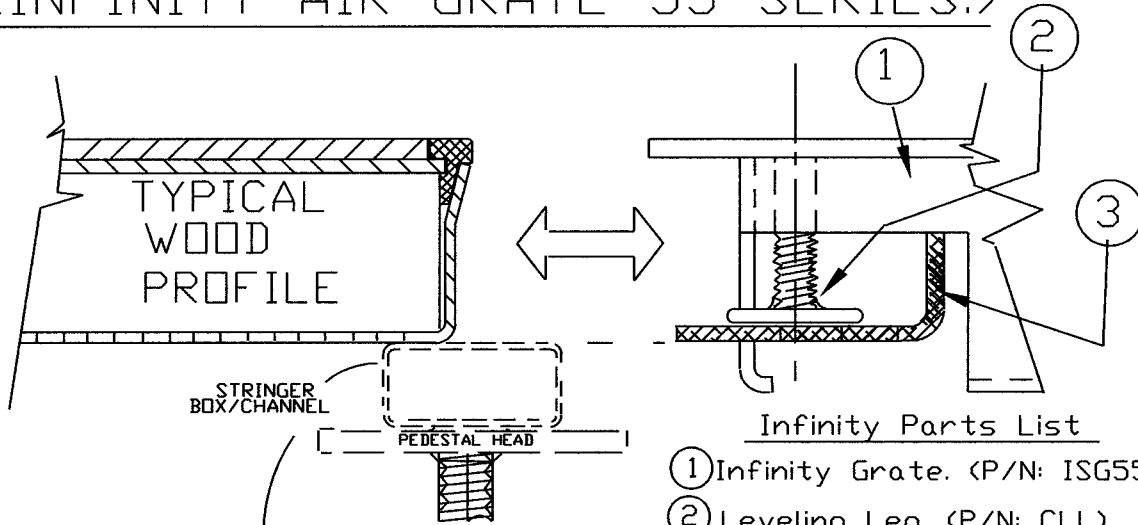

- ① Infinity Grate. (P/N: ISG55-15).
- ② Leveling Leg. (P/N: CLL)
- ③ "Z" plate. (P/N: ZPW)

MFR: ASM/MAXCESS

Stringer dims, 22.7/8" L
7/8" W
1.1/8" H
Hole Ctrs, 22"
Stringer Type: Snap on.

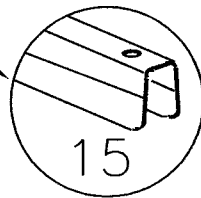

MFR: Computer Environments

Stringer dims, 21.7/8 L
1.1/8" W
3/4" H
Hole Ctrs, 21.1/2"
Stringer Type: Bolt on.

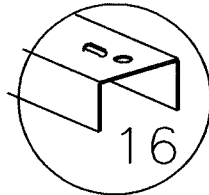

MFR: Tate/ Wood Core.

Stringer dims, 22.13/16" L
1" W
3/4" H
Hole Ctrs, 21"
Stringer Type: Bolt on.

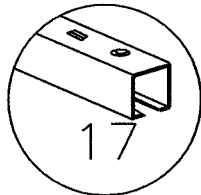

Unknown

MFR: ASM Modular Systems.
Stringer dims, 22.5/16" L
1.1/8" W
5/8" H
Hole Ctrs, 21.1/2"
Stringer Type: Bolt on.

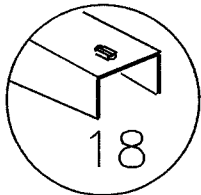

MFR: Camino Wood Core.

Stringer dims, 22.7/8" L
1" W
1.1/4" H
Hole Ctrs, 20.1/2"
Stringer Type: Bolt on.
Canadian design Old Style.

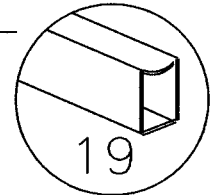

USE INFINITY PARTS LIST ABOVE FOR STRINGER APPLICATIONS.
SHOWN ON LOWER PAGE AREA.

"APPLICATION GUIDE" (INFINITY AIR GRATE-55 SERIES.)

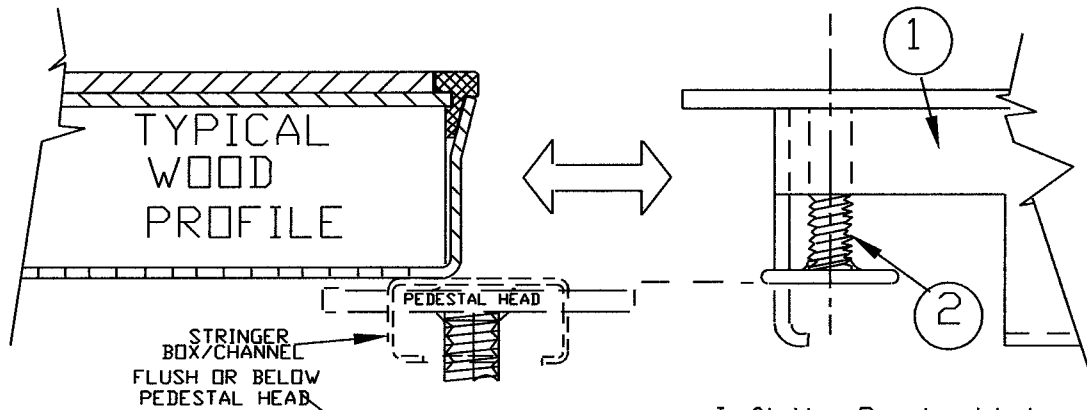

Infinity Parts List

- ① Infinity Grate. (P/N: ISG55.-15)
- ② (Leveling Leg. (P/N: CLL).

MFR. C-Tec PSL-1
 Stringer dims, 22.5/8" L
 5/8" W
 1" H
 Hole Ctrs, 21.7/8"
 Stringer Type: Twist-on/Bolted.

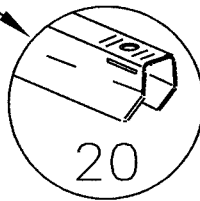

MFR: Custom.
 Stringer dims, 23.1/4" L
 1" W
 1" H
 Hole Ctrs, 20.3/4"
 Stringer Type: Bolt on.



MFR: Westinghouse
 Stringer dims, 22.7/8" L
 1" W
 9/16" H
 Hole Ctrs, 22.5/16"
 Stringer Type: Bolt on.
 Wood Core

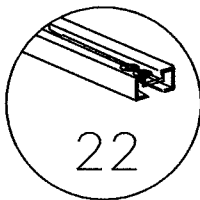

USE INFINITY PARTS LIST ABOVE FOR STRINGER APPLICATIONS.
 SHOWN ON LOWER PAGE AREA.

"APPLICATION GUIDE" (INFINITY AIR GRATE 53 SERIES.)

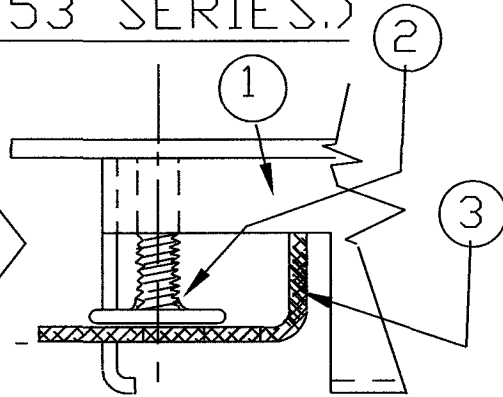
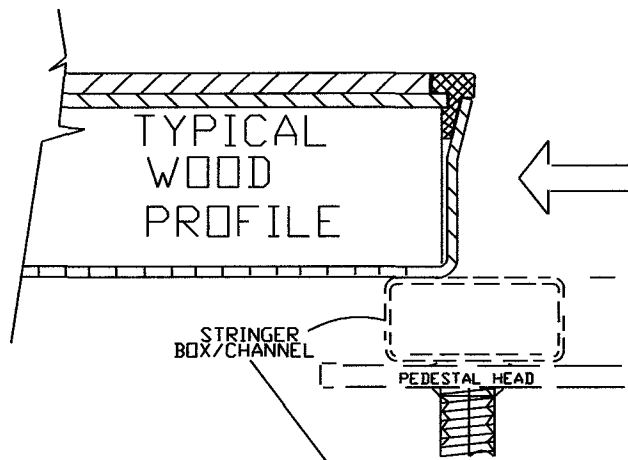

Infinity Parts List

- ① Infinity Grate. (P/N. ISG53C-15)
- ② Leveling Leg. (P/N, CLL)
"Included"
- ③ "Z" plate, (P/N, ZPW).
"Included"

MFR. Computer Environments

Stringer dims, 22.5/16" L
1.1/2" W
13/16" H
Hole Ctrs, 21.1/4"
Stringer Type: Bolt on.

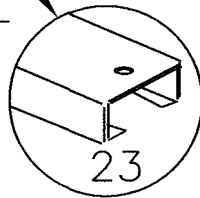

MFR. Donn/Low Profile

Stringer dims, 22.15/16" L
1.1/4" W
5/8" H
Hole Ctrs, 21.7/16"
Stringer Type: Bolt on.

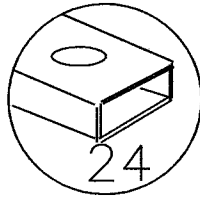

MFR: Waco 101

Stringer dims, 21" L
1.1/4" W
13/16" H
Hole Ctrs, N/A.
Stringer Type: Snap on.

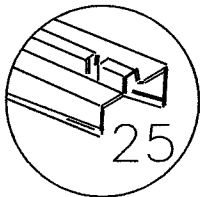

MFR: MaxcessWC5000

Stringer dims, 22.1/8" L
1.5/8" W
13/16" H
Hole Ctrs, 21.1/8"
Stringer Type: Bolt on.

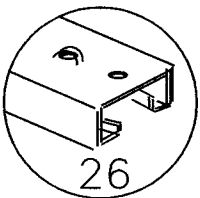

MFR. FSF Floors

Stringer dims, 22.5/16" L
1.1/4" W
7/8" H
Hole Ctrs, 21.1/4"
Stringer Type: Bolt on.

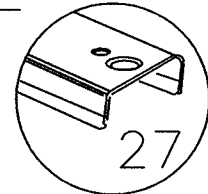

USE INFINITY PARTS LIST ABOVE FOR STRINGER APPLICATIONS.
SHOWN ON LOWER PAGE AREA.

"APPLICATION GUIDE" (INFINITY AIR GRATE 53 SERIES.)

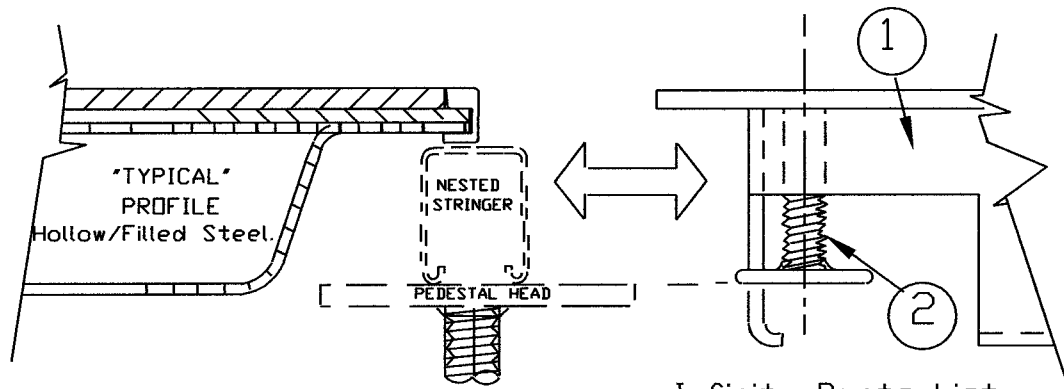

Infinity Parts List

- ① Infinity Grate. (P/N: ISG53L-15).
- ② 1" Leveling Leg, P/N: CLX). INCLUDED

MFR. Tate/Mark 20/30

Stringer dims, 22.7/8" L
 (1.7/16" w/pad.) 1" W
 1.1/4" H
 Hole Ctrs, 22"
 Stringer Type: Bolt on.

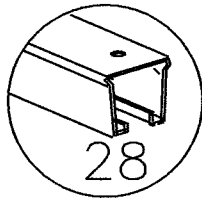

MFR. C-Tec/IAR/Haworth.

Stringer dims, 22.7/8" L
 1.3/16" W
 1.1/16" H
 Hole Ctrs, 22"
 Stringer Type: Bolt on.

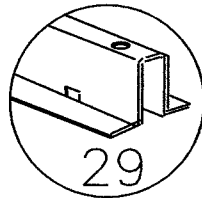

USE INFINITY PARTS LIST ABOVE FOR STRINGER APPLICATIONS.
 SHOWN ON LOWER PAGE AREA.

(INFINITY AIR GRATE)

INFINITY PARTS LIST (VARIES) CONSULT FACTORY.

MFR: Unknown
 Stringer dims, 22.1/2" L
 1.1/2" W
 1.3/4" H
 Hole Ctrs, 21.1/2"
 Stringer Type: Bolt on.
 Heavy Duty Floor.

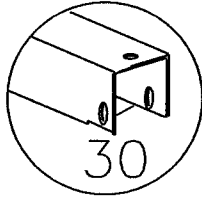

MFR: TateModel 801
 Stringer dims, 22.15/16" L
 3/4" W
 1" H
 Hole Ctrs, N/A.
 Stringer Type: Snap on.

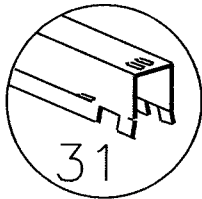

MFR: Donn/Snap on
 Stringer dims, 22.7/8" L
 3/4" W
 1.1/4" H
 Hole Ctrs, N/A
 Stringer Type: Snap on.

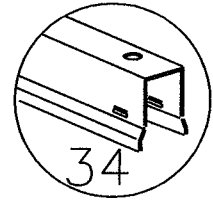

MFR: Donn
 Stringer dims, 22.3/4" L
 1" W
 1.13/16" H
 Hole Ctrs, N/A
 Stringer Type: Bolt on.

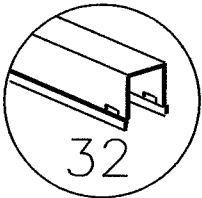

MFR: Custom.
 Stringer dims, 22.11/16" L
 1/2" W
 1" H
 Hole Ctrs, 21"
 Stringer Type: Bolt on.
 Use with C-Tec snap on pedestals
 on stringerless applications

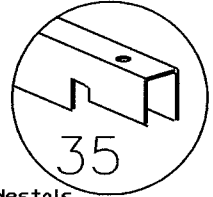

MFR: Unknown Custom.
 Stringer dims, 22.11/16" L
 13/16" W
 1.1/4" H
 Hole Ctrs, 21.9/32"
 Stringer Type: Bolt on.

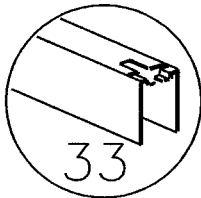

MFR: Unknown Custom.
 Stringer dims, 22.7/16" L
 5/8" W
 1" H
 Hole Ctrs, 21.11/16"
 Stringer Type: Bolt on.

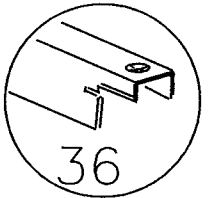

MFR: Custom, Tate 802 for Europe..
 Stringer dims, 22.7/16" L
 5/8" W
 2" H
 Hole Ctrs, 21.5/8"
 Stringer Type: Bolt on.
 European version of the series 802

